

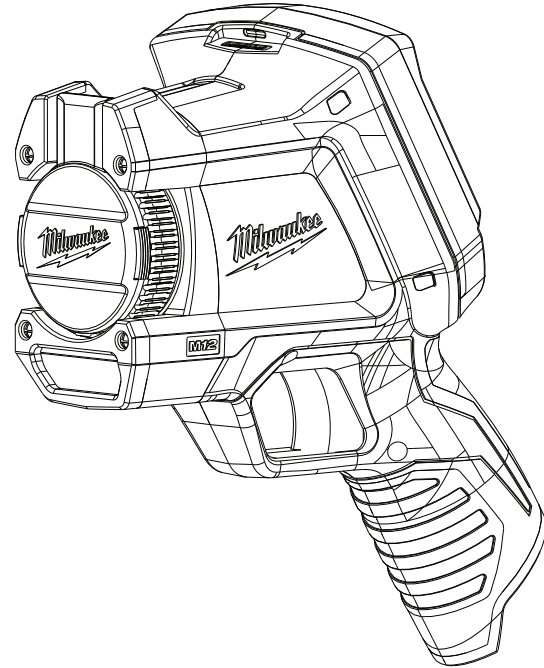

OPERATOR'S MANUAL

Cat. No.
2260-21

M12™ 160x120 Thermal Imager



***TO REDUCE THE RISK OF INJURY, USER MUST READ AND UNDERSTAND
OPERATOR'S MANUAL.***

Contents

Safety Information	1
Introduction.....	3
How to Use the Manuals	4
Obtaining Technical Support or Service	5
Unpacking the System.....	6
Charging and Installing the Battery	8
Installing the SD Memory Card.....	8
Controls and Features	9
Battery Life and Power-Saving Features.....	13
Taking a Basic Thermal Picture	14
Using the Built-In Visual Image Camera.....	16
Reviewing Saved Images	16
Optimizing Thermal Images.....	17
Manual Range and Auto Range	19
Changing the Color Palette	21
Changing the Settings	22
Specifications	23
Glossary	25

Safety Information

WARNING

READ ALL SAFETY WARNINGS AND INSTRUCTIONS

Failure to follow the warnings and instructions may result in electric shock, fire and/or serious injury. *Save these instructions* - This OPERATOR'S MANUAL contains important safety and operating instructions for this Thermal Imager. Before using the Thermal Imager, read this OPERATOR'S MANUAL, the M12 Battery Charger and Battery OPERATOR'S MANUAL, and all labels on the battery pack, charger and Thermal Imager.

- **Avoid dangerous environments.** Do not use in rain, snow, damp or wet locations. Do not use in the presence of explosive atmospheres (gaseous fumes, dust or flammable materials) because sparks may be generated when inserting or removing battery pack, possibly causing fire or explosion.

BATTERY USE AND CARE

- **Recharge only with the charger specified by the manufacturer.** A charger that is suitable for one type of battery pack may create a risk of fire when used with another battery pack.
- **Use power tools only with specifically designated battery packs.** Use of any other battery packs may create a risk of injury and fire.
- **When battery pack is not in use, keep it away from other metal objects like paper clips, coins, keys, nails, screws, or other small metal objects that can make a connection from one terminal to another.** Shorting the battery terminals together may cause burns or a fire.

SERVICE

- **Have your Thermal Imager serviced by a qualified repair person using only identical replacement parts.** This will ensure that the safety of the tool is maintained. MILWAUKEE Tool Company recommends service and calibration at a MILWAUKEE Service Center annually.
- **Do not disassemble.** Incorrect reassembly may result in the risk of electric shock or fire. If it is damaged, take it to a MILWAUKEE service facility.
- **Store in a cool, dry place.** Do not store where temperatures may exceed 120 °F (50 °C) such as in direct sunlight, a vehicle or metal building during the summer.
- **Do not remove or deface labels. Maintain labels and nameplates.** These carry important information. If unreadable or missing, contact a MILWAUKEE service facility for a free replacement.



Federal Communications Commission WARNING: Changes or modifications to this unit not expressly approved by the party responsible for compliance could void the user's authority to operate the equipment. This equipment has been tested and found to comply with the limits for a Class B digital device, pursuant to Part 15 of the FCC Rules. These limits are designed to provide reasonable protection against harmful interference in a residential installation. This equipment generates, uses and can radiate radio frequency energy and, if not installed and used in accordance with the instructions, may cause harmful interference to radio communications. However, there is no guarantee that interference will not occur in a particular installation. If this equipment does cause harmful interference to radio or television reception, which can be determined by turning the equipment off and on, the user is encouraged to try to correct the interference by one or more of the following measures:

- Reorient or relocate the receiving antenna.
- Increase the separation between the equipment and receiver.
- Connect the equipment into an outlet on a circuit different from that to which the receiver is connected.
- Consult the dealer or an experienced radio/TV technician for help.

Introduction

Model 2260-21 M12™ 160x120 Thermal Imager is an ultra-rugged, hand-held battery-powered tool that takes thermal pictures, called “thermal images.” Thermal images reveal different temperatures as different colors. A bright color display shows an image of hot and cold spots and temperature gradients in-between. The temperature of the object in the center target is shown at the top of the thermal image. Information about the temperature range and color palette settings for the image are on the bottom of the image. See Figure 1.

You can optionally load the thermal images onto a computer to prepare a report later. The Thermal Imager and its supplied PC software satisfy the requirements of industrial electricians and technicians new to thermal imaging, as well as expert professional thermographers.

MILWAUKEE Thermal Imager Report Software is included on the CD (Compact Disk). Instructions for using the software are in the MILWAUKEE Thermal Imager Report Software Manual, which is on the supplied CD.

With the software, you can organize, choose, annotate and adjust images and present results in a report. In your report, you can write recommendations and add your company logo.

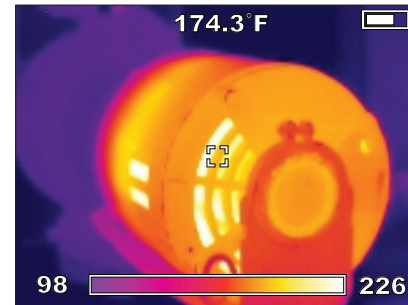
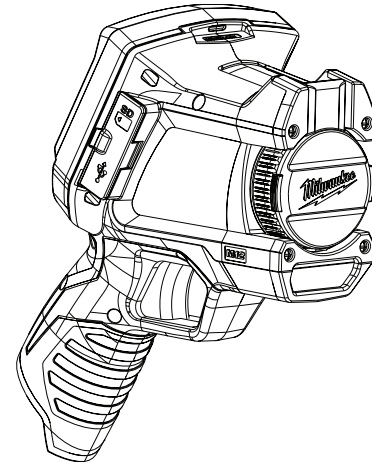

Figure 1. Thermal Imager and a Thermal Image

How to Use the Manuals

All of the manuals needed to safely and properly operate the Thermal Imager are available in Adobe® PDF (Portable Document Format) on the CD. You can easily load these PDF documents from the CD or from the *MILWAUKEE* website onto your computer. There, you read them on the computer screen, search for topics or keywords, or print pages from them.

NOTE

To open and read the PDF manuals, your PC uses Adobe® Acrobat®. If your PC does not already have Acrobat Reader, you can install it at no cost by following the prompts on the PC when you run the CD supplied with your Thermal Imager. Adobe® and Adobe Reader® are registered trademarks of Adobe Systems Incorporated in the United States and other countries.

The following manuals are supplied with the Thermal Imager:

- **M12 160x120 Thermal Imager Operator's Manual:** this explains how to use the Thermal Imager. Thermal Imager Specifications and a Glossary of Terms are located at the back of this manual.

- **Thermal Imager Report Software Manual:** this explains how to use *MILWAUKEE* Thermal Imager Report Software to produce a report. You load this manual onto your computer from the product CD when you install the software. It opens for viewing whenever you press F1 or "Help" while using the software.
- **M12 Battery Charger and Battery Operator's Manual:** this is a printed booklet that you should read and understand before using the product. It contains important warnings and information for proper battery handling and charging. Improper usage, handling or charging of the batteries can cause risk of fire or injury. You must first charge the battery before you use the Thermal Imager.
- **Warranty and Safety Information:** this is a printed booklet with the Warranty, safety information from the Operator's Manuals for the battery, charger and Thermal Imager and an explanation of symbols on the product and in the documentation.
- **Reference Card:** this is a printed, folded, pocket-sized, picture-based guide. It gives you visual step-by-step instructions for basic workflow using with the Thermal Imager system.

Obtaining Technical Support or Service

Visit www.milwaukeeetool.com online and click on Service. There you can search for the nearest factory authorized Service Center. You can also find how to contact someone at *MILWAUKEE* by email, telephone, or postal mail.

NOTE

Always contact a Service Center first for instructions and a return authorization number (RMA) before you ship any product for service or calibration.

The mailing address for the main *MILWAUKEE* Service Center is:

MILWAUKEE Service Center
13145 West Lisbon Rd.
Brookfield, WI 53003
USA

Unpacking the System

The complete system comes packed in a rugged portable hard case. Figure 2 and Table 1 identify each item. If anything is missing, contact the point of purchase.

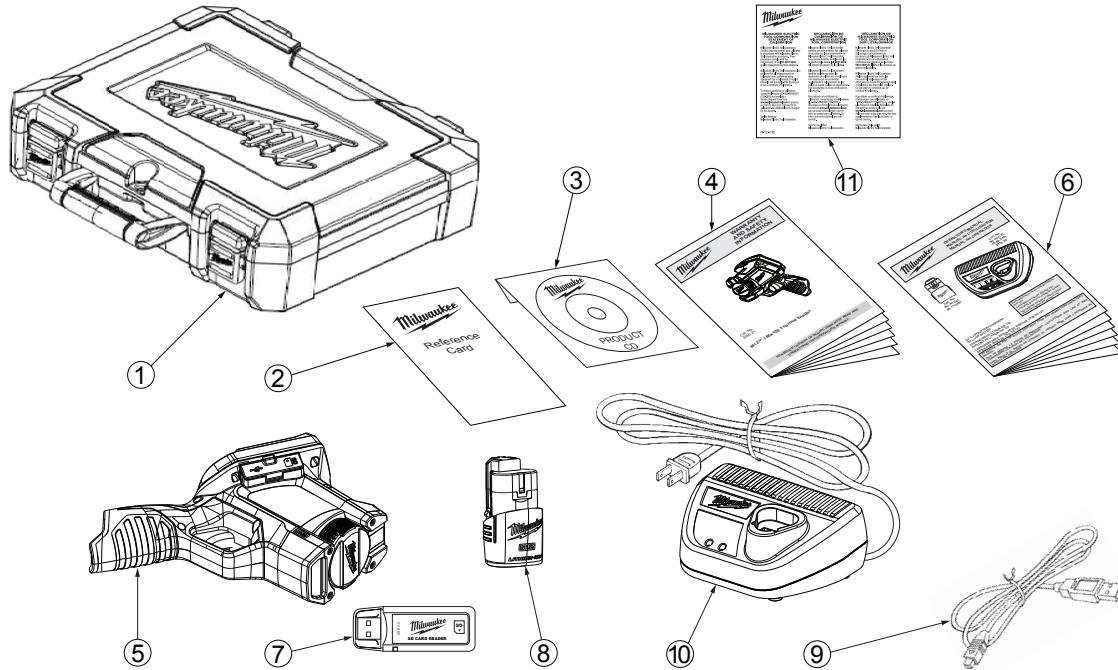

Figure 2. Identifying Items in the Hard Case

Table 1. Identifying Items in the Hard Case

No.	Item	Model or Part Number
1	Hard Carry Case	42-55-2265
2	Reference Card	58-22-0240
3	Product CD with software and manuals in PDF format	58-99-0015
4	Warranty and Safety Information booklet	22-74-3005
5	M12 160 x120 Thermal Imager	2260-20
6	M12 Battery Charger and Battery Operator's Manual	58-14-2402
7	SD Memory Card Reader with USB (Universal Serial Bus) plug for attaching to a PC to transfer images	22-80-0110
8	M12 Rechargeable Li-Ion Battery	48-11-2401
9	Mini USB to Type A USB cable to connect the Thermal Imager to a PC to transfer images	42-44-0205
10	M12 Li-Ion Battery Charger	48-59-2401
11	Statement of Calibration	58-22-0190

Charging and Installing the Battery

Read and understand the warnings and instructions in the Battery Charger Operator's Manual. Charge the battery until the green indicator on the Battery Charger appears. It takes approximately 30 minutes to reach a full charge with the supplied M12 battery. Any **MILWAUKEE** M12 Series battery will work with the Thermal Imager.

To avoid damage or injury, use only a genuine **MILWAUKEE** M12 battery and charger, and follow the charging and handling instructions supplied with the Battery Charger. Snap the battery into place until it locks into the Thermal Imager's hand grip as shown in Figure 4.

Accessing the SD Memory Card

The SD card is installed in the Thermal Imager at the factory. The Thermal Imager does not store any images without one installed.

To remove and re-install the SD card, refer to Figure 3 and proceed as follows:

1. Flip open the rubber dust and water cover toward the front of the Thermal Imager.
2. If an SD card is already installed, you will see it in the upper half of the area under the rubber cover.

3. To remove it, press it in gently and it releases so you can pull it out.
4. If an SD card is not installed, insert the SD card with the label facing the front of the Thermal Imager (the side with the lens). It fits only one way. Do not use excessive force.
5. Gently press it until the SD card clicks and locks in place. Press it again to release it. Leave it locked into place and close the rubber dust and water cover.

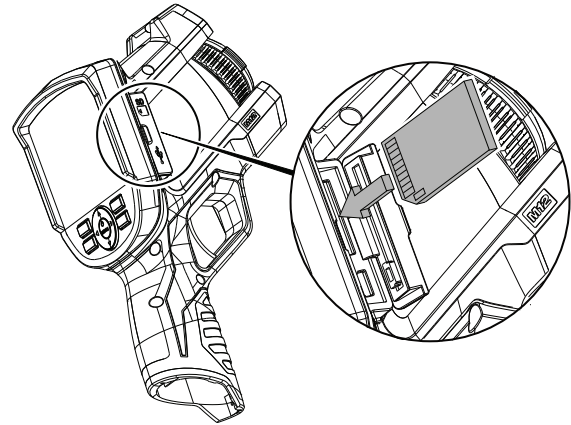

Figure 3. Installing the SD Card

Controls and Features

Figure 4 and Table 2 identify the location and explain the function of the buttons, controls and features. See Table 3 for a list of all the symbols printed on the Thermal Imager and the meaning of each. Figure 5 and Table 3 explain the meaning of symbols and information on the display when it is showing a thermal image.

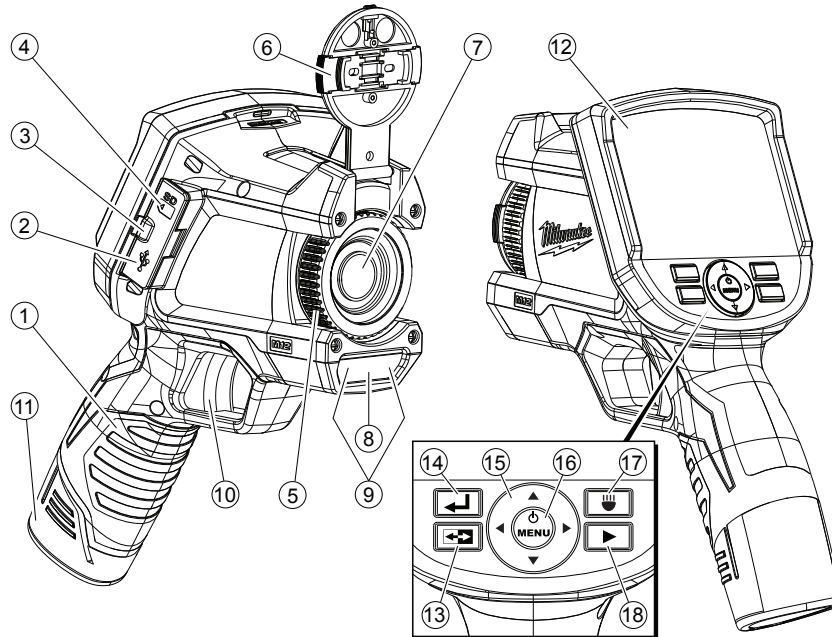

Figure 4. Locating the Controls and Features

Table 2. Controls and Features

No.	Name	Function
1	Hand grip	Grip this when you use the Thermal Imager. The hand grip also holds the removable M12 rechargeable battery.
2	Mini USB socket	Plug the USB cable into this socket when you want to connect the Thermal Imager to a computer. This is one way to transfer images to a computer.
3	Media door	A rubber-flap protective cover that keeps dust and moisture out of the USB socket and SD memory card socket when you are not using these sockets.
4	SD card socket	Push the SD memory card in to install it. Push it again to release it. It fits only one way. Do not use excessive force.
5	Thermal imager focus ring	Turn in small increments and wait for the thermal image to refresh on the display. This focus ring does not affect the visual image.
6	Thermal imager lens cap	To open for use, squeeze the side release tabs, lift the lens cap up and snap it in place on top of the Thermal Imager. To protect the lens, replace the lens cap when you are not using the Thermal Imager.
7	Thermal imager lens	Focuses incoming infrared (IR) radiation on to the IR sensor to make a thermal image. You manually focus this lens for the sharpest thermal image on the display.
8	Visual digital camera lens	There is no need for any focus adjustment. All visual images are fixed-focus.
9	LED flashlight	Press the  button to turn on and off the LED flashlight. The LED flashlight illuminates the area you are photographing. It is used only to improve images from the built-in visual digital camera and to help you see in a dark area. The LED flashlight does not affect thermal images in any way.
10	Trigger	Squeeze the trigger to take a picture. This takes both a thermal and visual image. Squeeze it again to save the image. Alternatively, choose [CANCEL] from the keypad to discard the image.
11	Battery	Insert and push until it locks in place. To remove, squeeze the sides to release the battery. Any <i>MILWAUKEE</i> M12 series battery is compatible.
12	Display	This is the color screen for viewing live or stored images and for making choices in the Setup Menu.

Table 2. Controls and Features (continued)













No.	Name	Function
13	 (Toggle button)	Press  to toggle between thermal image display and visual image display. The toggle button works in both live view and image review.
14	 (Back button)	Press  to revert to the most recent operating condition.
15, 16		This part of the keypad has up, down, left and right cursor movement buttons for selecting items in menus and selecting images in image review mode. The center button turns the power on or off, opens the Setup Menu, or confirms an action such as CANCEL or SAVE or a menu selection.
17	 (LED flashlight button)	This button turns the LED flashlight on and off. The LED flashlight illuminates the subject area for the visual digital camera and for the user. The default setting is off.
18	 (Review button)	Calls up stored images for reviewing on the display. Press  to return to live operation.

Table 3. Symbology

Symbol	Meaning
	Read the Operator's Manual.
	Danger, Warning, or Caution - Consult the operators manual for additional safety information.
	Battery symbol

Symbol	Meaning
	European Conformity Mark
	Do not dispose of this product as unsorted municipal waste.

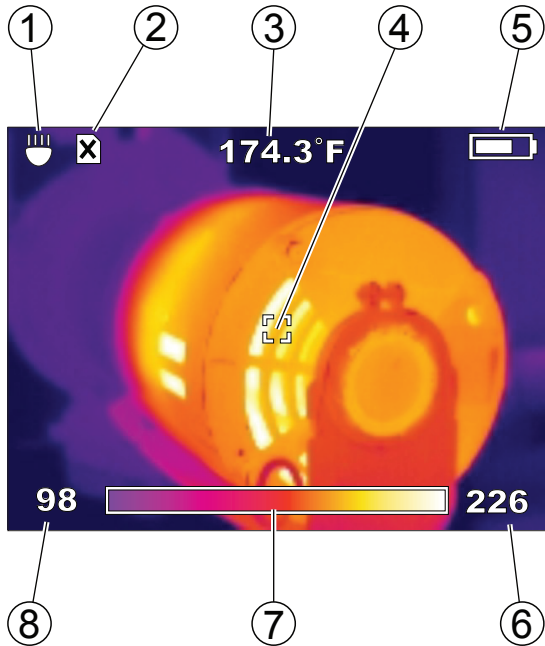



Figure 5. Elements of the Thermal Image Display

Table 4. Explanation of Display Elements

1	LED flashlight is on
2	SD card is not installed (you cannot save images)
3	Target temperature
4	Target
5	Battery charge indicator (more white = more charge remaining)
6	Upper limit of range
7	Picture of color palette in use ("Iron" is shown)
8	Lower limit of range

Battery Life and Power-Saving Features

To preserve battery life, the Thermal Imager goes into Sleep Mode after 5 minutes of no activity. Sleep Mode maintains a ready-to-go, warmed-up condition, but uses a fraction of normal operating battery current. After another 15 minutes of no activity, the Thermal Imager turns itself completely off. Although you can turn off the Thermal Imager with the  button, you never have to because of its auto power-off feature.

Using the supplied M12 battery, continuous operating time is at least 3 hours with the LED flashlight off. If you are using the Thermal Imager intermittently, Sleep Mode extends operating time to an entire work day or longer.

A Fuel Gauge on the Thermal Imager display shows the capacity remaining in the battery. See Figure 6. When 10% of charge remains, the Fuel Gauge reads empty and blinks on and off. This is the time to replace the battery with a charged one, or charge the battery as soon as you can. When no charge remains, a Low-Battery Message appears on the display for 3 seconds. Then the Thermal Imager shuts itself off.

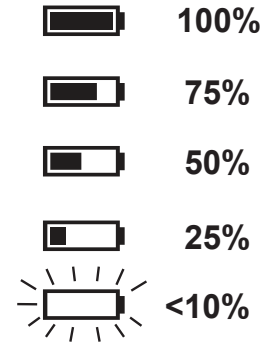

Figure 6. Battery Fuel Gauge Levels and Imminent Shutdown Warning

Taking a Basic Thermal Picture

Proceed as follows to capture and save a basic image set:

NOTE

An SD card must be installed for the Thermal Imager to save images and data. If no SD card is installed, you will see the error message on the display: “NO SD CARD.”





1. Press and hold  (center button on the directional keypad) for 2 to 3 seconds until you see activity on the display.
2. The Thermal Imager displays progress messages about Sensor Calibration during warm-up. From Sleep Mode, warm-up is almost instantaneous. Until warm-up is complete, button presses are ignored.
3. If the time and date are not already set, the Settings Menu appears so you can set these.

Figure 7 shows TIME selected for setting. To set the time, press the  button to open the time setting menu. Use the arrow keys to set the current time, then press the  button to return to SETTINGS. Press 

twice to select DATE, then set the date the same way you set the time. Once any settings are changed, the new settings stay in memory when the power is turned off.



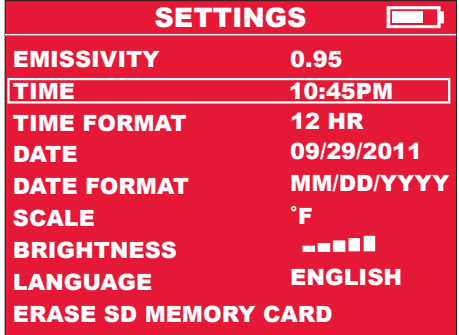

SETTINGS 	
EMISSIVITY	0.95
TIME	10:45PM
TIME FORMAT	12 HR
DATE	09/29/2011
DATE FORMAT	MM/DD/YYYY
SCALE	'F
BRIGHTNESS	
LANGUAGE	ENGLISH
ERASE SD MEMORY CARD	

Figure 7. Setting Time

4. Open the lens cap by pinching the buttons on the sides of the lens cap. Flip it open until it snaps in place on top of the Thermal Imager.
5. Observe the live thermal image on the display as shown in Figure 8. Rotate the focus ring on the thermal sensor lens for maximum sharpness. Make small focus adjustments and wait for the image to settle before making another adjustment. Focusing has a different feel than it does with visual image cameras.

In the live thermal image in Figure 8, the 411.3 °F reading at the top of the display is the temperature inside the center target. The bottom of the display shows the color palette over the temperature span (in this case, 370 °F to 446 °F). Span is adjusted automatically in auto-range mode (default setting). This manual explains how to use manual range settings under “Optimizing Thermal Images.”

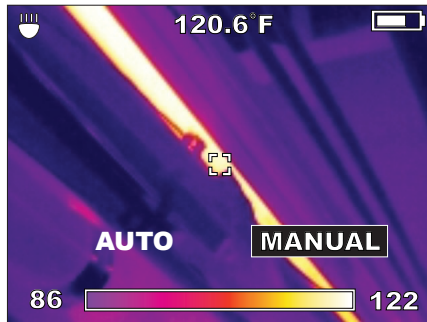

Figure 8. Live Thermal Image

6. When the display shows the object or scene framed the way you want it, pull the trigger to take a thermal picture. The display then presents you with choices to SAVE or CANCEL the new image. See Figure 9.

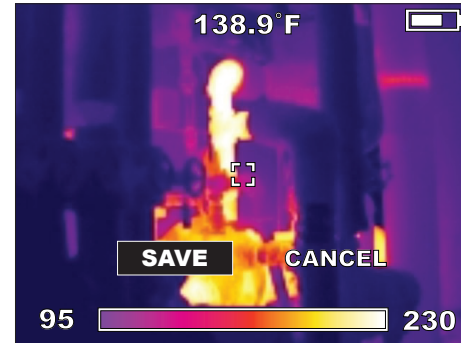





Figure 9. SAVE or CANCEL a New Image

7. To write the image to SD card, press the  button on the arrow keypad or pull the trigger again. Or, to discard the image, press the  arrow button to highlight CANCEL, then press the  button.

NOTE

Every minute, the Thermal Imager pauses to calibrate its thermal sensor. You will hear clicking sounds. This is normal behavior. The Thermal Imager does not respond to button presses during calibration pauses.

Using the Built-In Visual Image Camera

Every time you take a thermal picture, the Thermal Imager captures a visual image at the same time. When you save a thermal image, the Thermal Imager saves the visual image that goes with it as well. Just like with thermal images, you can see live visual images on the display. Press the  button to switch between thermal and visual images.

Figure 10 shows a visual image as it would appear on the display. This is the companion to the thermal image in Figure 8. There is no temperature data associated with a visual image. Visual images are to help you identify objects in thermal images.

The visual image camera has its own lens. It is fixed-focus. (No focus adjustment is necessary.) The visual image camera lens is a small rectangular window below the lens, forward of and above the trigger.

NOTE

If visual images ever seem to have poor quality, check to see if this lens is dirty. Clean it gently with a camera lens tissue moistened with camera lens cleaner fluid.

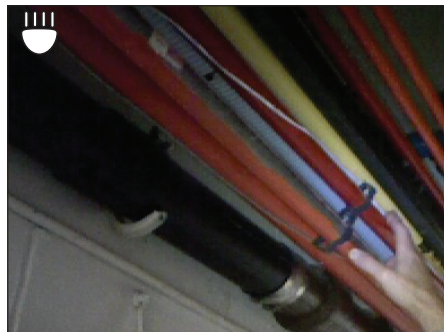







Figure 10. Live Visual Camera View

Press  again to return to the thermal image view.

Reviewing Saved Images

Proceed as follows to review or “play back” saved thermal and visual images:

1. Press the  button. This displays the most recent thermal image. At any time during review, you can press  to see its companion visual image.
2. Press  (directional arrow on the keypad) to continue reviewing the next older image. Press  to move to the next more recent images.
3. To return to live view, press .

Optimizing Thermal Images

Once you become familiar with basic operation, you're ready to discover the image enhancement and refinement you can achieve using custom settings. The custom setting that has the most impact on temperature reading accuracy is Emissivity. If you select only one custom setting, this is the one to change. All the custom settings that affect the accuracy of your data are:

- Auto or Manual Range (default is Auto) – Gives you control over the lowest and highest temperature.
- Span (default is the Imager's Range, or widest temperature range from lowest to highest temperature that the Imager can detect). A custom span setting lets you narrow the range of temperatures. This reveals small temperature variations as different colors. The Span setting is like reducing the scale in a graph, magnifying small variations for easier viewing.
- Level (no default) – Level is always the center point of the Span or Range.
- Palette (default is “IRON”) – The Palette is the color scheme for the display and saved thermal images.
- Emissivity (default is 0.95 - rubber, asphalt, concrete, black electrical tape) – Adjusts the Imager to compensate for different target surface materials.

Emissivity

Press **⏺**, select SETUP, then press **⏺** to get the Setup Menu as shown in Figure 7. Press **▲** and **▼** as necessary to select “EMISSIVITY.” This brings up the Emissivity Menu as shown in Figure 11.

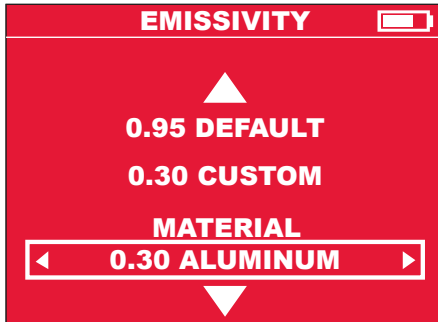

Figure 11. Emissivity Menu

This setting tells the Thermal Imager what surface material it is measuring. This is important, because setting the right emissivity has a significant effect on the accuracy of temperature readings. See Table 5 for a list of the materials in the Thermal Imager Emissivity menu, and their corresponding emissivity ratios. You can also select “CUSTOM” in the emissivity menu, and select any emissivity value. In Figure 11, “CUSTOM” shows “0.30,” but when you select CUSTOM, you can choose any value.

Emissivity is the ratio of a target surface’s infrared output (radiance) to that of a blackbody at the same temperature. A “blackbody” is a theoretical perfect radiator of infrared radiation (IR).

What this means is you can set the sensitivity of the Thermal Imager to determine the true temperature of an object, no matter what its IR radiation characteristics are. The poorest radiators (surfaces with the lowest emissivity ratios) need the most correction. These materials are things like shiny metal and glass.

When you have a low-emissivity surface that you need a very accurate temperature reading from, placing black electrical tape or even painting it with flat-black paint is very effective. Black electrical tape and flat-black painted surfaces have an emissivity ratio of 0.95.

⚠ WARNING

To minimize the risk of electric shock, burn or fire, never apply electrical tape or paint to an electrically live surface. Always check to ensure the power has been turned off before touching a surface.

Table 5. Menu Choices for Target Materials and their Corresponding Emissivity Ratios

Material in Emissivity Menu	Corresponding Emissivity Ratio
ALUMINUM	0.30
ASPHALT	0.95
BRICK	0.83
CONCRETE	0.95
COPPER	0.60
IRON	0.70
OIL (PETROLEUM)	0.94
PAINT	0.93
RUBBER	0.95
SAND	0.90
SOIL	0.92
STEEL	0.80
WATER	0.93
WOOD	0.94

Manual Range and Auto Range

When you turn on the Thermal Imager, it is always in AUTO RANGE mode. This means that it automatically selects the lowest temperature and highest temperature in its range to make thermal images. Usually, this produces the best results. However, if you want to use a narrower or wider temperature range, you can select MANUAL RANGE.

Typical reasons for selecting MANUAL RANGE:

- An area in the field of view that you want to focus on has a narrow range of temperatures, and you want to be able to resolve these small differences. For this, you would set a narrower MANUAL range than AUTO RANGE.
- There is one extremely hot point in the field of view, and you want to make sure that it gets measured. For this, you would set a wider MANUAL range than AUTO RANGE.
- There are both very cold and very hot objects in the field of view, and you want to make sure to measure both temperature extremes. For this, you would set a wider MANUAL range than AUTO RANGE.

To Set a MANUAL range, proceed as follows:

1. From live view mode, press  then select RANGE. The display appears as in Figure 12:

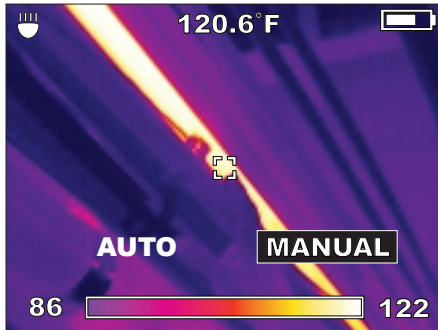

Figure 12. Setting Manual Range







2. Press  to select MANUAL range. The display appears as in Figure 13 (this example is using a different target image):



Figure 13. Setting Level and Span for Manual Range

3. Press  and  to experiment with the SPAN setting to choose the best looking display for the area you are studying.
4. Press  and  to experiment with the LEVEL setting to choose the best looking display for the area you are studying. When you move the LEVEL, you shift the whole fixed window of temperature range up or down.
5. Press  to accept your custom LEVEL and SPAN settings and remain in MANUAL range mode.

Changing the Color Palette

The default color palette is called “IRON.” IRON, RAINBOW and GRAY are all shown in Figure 14. IRON is the default. It is better at revealing small temperature differences.

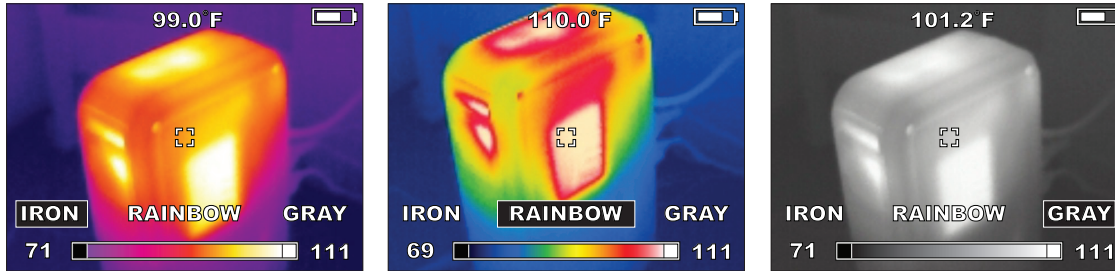





Figure 14. IRON, RAINBOW and GRAY Color Palette Choices

You can change to two other color palettes: “RAINBOW” and “GRAY.” GRAY shows the most detail and is useful for record keeping or reporting in formats that do not allow the use of color. RAINBOW is an alternative to IRON, which uses more colors. RAINBOW is better for show a very wide range of temperatures because of the additional colors. To change the color palette, proceed as follows:

1. From the live view mode, press then if needed to select COLOR, then . This opens the menu bar shown in Figure 14. Press the and arrow buttons to make your selection, then press to confirm it.

Changing the Settings

Use the SETUP menu to set the TIME, TIME FORMAT, DATE, DATE FORMAT, SCALE (°F or °C), BRIGHTNESS, LANGUAGE, and the way to erase images on the installed SD memory card. To call up the SETTINGS menu, from live mode press , then  if needed to select **SETTINGS**, then  to confirm your selection. The SETTINGS menu is shown in Figure 15.

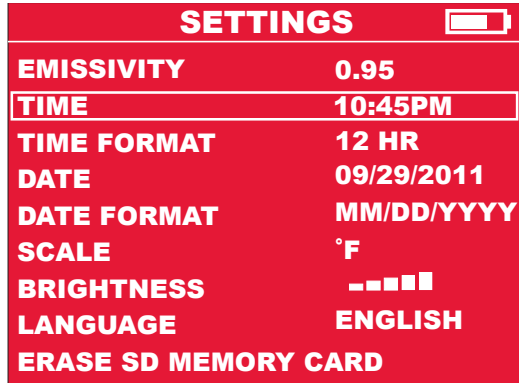









SETTINGS 	
EMISSIVITY	0.95
TIME	10:45PM
TIME FORMAT	12 HR
DATE	09/29/2011
DATE FORMAT	MM/DD/YYYY
SCALE	°F
BRIGHTNESS	
LANGUAGE	ENGLISH
ERASE SD MEMORY CARD	

Figure 15. The Settings Menu

1. Press  and  to select the menu item to set, followed by  to confirm your selection.
2. Press  and  to change the setting, followed by  to confirm the change. Changes you make to settings remain in effect even after you turn off the power and turn it back on again.

Specifications

PHYSICAL AND ENVIRONMENTAL	
Drop test	3' (1m) drop to concrete
Operating temperature range	14°F to 122°F (-10°C to +50°C)
Operating and storage humidity range	10% to 90%, non-condensing
Storage temperature range without battery ¹	-13°F to 140°F (-25°C to +60°C)
TEMPERATURE MEASUREMENT	
Infrared (IR) resolution	160 X 120 pixels (picture elements, or data points)
Object temperature range ²	14°F to 662°F (-10°C to 350°C)
Thermal sensitivity	0.1°C per 30°C Noise Equivalent Temperature Difference (NETD)
Spatial resolution	2.7 mrad Instantaneous Field of View (IFOV)
Accuracy	±4°F (2°C) or ±2% or reading, whichever is greater
On-board adjustable emissivity	Variable from 0.01 to 1.00, in increments of 0.01
Infrared (IR) detector type	Uncooled microbolometer focal-plane array (FPA)
Spectral range	8 to 14 μm
THERMAL IMAGING	
Field of view (FOV)	25° Horizontal X 19° Vertical
Focus method	Manual
Minimum distance in focus	3.9".(10 cm)
Screen refresh	60 Hz

VISUAL IMAGING	
Visual digital camera resolution	1.3 Megapixels
Field of View	56° Horizontal X 46° Vertical
Minimum distance in focus	11.8 in. (30 cm)
Focus method	Fixed
Exposure control	Auto
LED flashlight3	User-selectable on or off
GENERAL	
Battery system	MILWAUKEE M12 Series rechargeable Li-Ion removable battery and M12 Series drop-in battery charger
Image storage system	Removable 2 GB SD card installed, room for >300 image sets. The Thermal Imager is tested to accommodate up to 32GB SD card (>4,800 image sets).
Data communication interface	Mini USB with rubber flap called the media door to seal out dust and water
Display	Color TFT-LCD 3.5 in. (9 cm) measured diagonally
<p><i>Note 1: For the M12 rechargeable battery temperature and humidity ranges, refer to its Operator's Manual</i></p> <p><i>Note 2: The Thermal Imager displays readings <10°C and >350°C, but these readings are not specified</i></p> <p><i>Note 3: The LED floodlight does not affect thermal images</i></p>	

Glossary

Term	Definition
160x120	The number of pixels (picture elements or dots) in a saved thermal image. Each pixel has a temperature associated with it. Each thermal image is 160 pixels wide by 120 pixels high.
accuracy	The guaranteed correctness of a temperature reading. For example, \pm (2° or 2% of reading), whichever is greater.
ambient temperature	The surrounding background or environmental temperature around the Thermal Imager.
blackbody	A blackbody absorbs all thermal radiation striking it and emits all of it back. This means that a perfect blackbody has an emissivity of exactly 1. Surfaces that are closest to a blackbody in real world applications are flat black paint and black electrical tape. (See “emissivity.”)
battery fuel gauge	A symbol on the display in the shape of a battery, with a bargraph indicating the level of remaining charge. The more white bars showing, the more charge remaining.
brightness level	Refers to the display brightness, which you can adjust in the Setup Menu.
calibrate, calibration	Comparing a measurement device’s readings to a reference standard. Calibration usually involves adjustment to correct for errors, but not always. In the Thermal Imager, an internal reference standard calibrates the unit once per minute. Also see “Calibration interval.”
calibration interval	The period of time after production or re-calibration that a measurement device’s specifications are valid --1 year for the Thermal Imager. After 1 year, contact a <i>MILWAUKEE</i> Service Center for factory calibration to renew the calibration cycle.
camera	Refers to the built-in visual image digital camera.
camera lens	Refers to the front optical element in the built-in visual digital image camera, located between the flashlight LEDs below the Thermal Imager lens. This is a fixed-focus lens – no adjustment required.

CD	Compact Disk. Also called a CD ROM, for CD Read-Only Memory. The CD supplied with the Thermal Imager contains software and manuals.
Celsius	A temperature scale based on 0 °C as the freezing point of water and 100 °C as the boiling point of water at a reference barometric pressure.
color palette, palette	A thermal image color scheme. Generally, black is the coldest and white is the hottest, but you can choose the colors that represent the intermediate temperatures in the scale. Palette is one of the Setup menu choices in the Thermal Imager: IRON, RAINBOW and GRAY.
detector	Also called “sensor,” the component that detects infrared radiation to determine temperatures. The Thermal Imager’s detector is a microbolometer. (See “microbolometer” and “FPA.”)
detector, Infrared	A transducer element that converts incoming radiant infrared energy striking its surface into an electrical signal.
directional keypad	The round group of arrow keys and center function key on the keypad.
display	The screen on the Thermal Imager that presents thermal or visual images and operating menu choices.
emissivity (ϵ)	The ratio of infrared emitted by an object divided by infrared emitted from a blackbody at the same temperature. The Thermal Imager allows you to select from a list of surface materials to maximize accuracy of the temperature readings. This is called “adjustable emissivity.” (See also “blackbody.”)
Fahrenheit	A temperature scale based on 32 °C as the freezing point of water and 212 °C as the boiling point of water at a reference barometric pressure.
field of view (FOV)	Stated in angular degrees, the width and height of the area that the Thermal Imager senses all incoming infrared energy to produce a thermal image.

fixed focus	An optical system for a camera or thermal imager that is set to one average distance, resulting in an in-focus range that is not adjustable.
FPA (focal-plane array)	A rectangular flat-panel matrix of detector elements on which the Thermal Imager's optical lenses and filters focus infrared energy to produce a thermal image. The type of FPA used in the Thermal Imager is called a microbolometer. It produces signals that make a new complete thermal image 60 times per second.
focal point	The distance from the lens at which the thermal imager is in focus.
focus distance	The closest distance at which you can focus the thermal image: 11.8 inches or 30 cm.
focusing ring	The movable ring around the front lens that you adjust for the sharpest thermal image. This has no effect on the visual digital camera image.
frame rate	The number of times per second that the Thermal Imager displays a completely updated thermal image: 60 times per second, or 60 Hz (Hertz).
full scale	The minimum temperature and the maximum temperature that the Thermal Imager can measure. When in AUTO RANGE mode, the Thermal Imager adjusts itself to a portion of full scale, called "span" that is somewhere within the full-scale endpoints. Using MANUAL RANGE settings, you can set the Thermal Imager to cover full scale, but usually this makes it more difficult to discern small temperature variations in the thermal image.
function key	The  button on the directional keypad. Its function changes depending on what activity is happening. It is often used as the ENTER key to confirm a menu selection.
image	Either a thermal image or a visual image. The Thermal Imager captures both kinds every time you pull the trigger. The pair of images are called an "image set." When you save, erase, or load an image to a PC, both the thermal and visual images always stay bundled together.

infrared (IR)	Electromagnetic energy in wavelengths that are between visible light and RF (radio frequency).
infrared detector	A transducer element (sensor) that converts incoming radiant infrared energy striking its surface into an electrical signal. The Thermal Imager measures this signal and translates it into a thermal image (Also see “bolometer.”)
IP rating	An international standard rating system for a device’s resistance to water and dust
JPEG (.jpg)	A file format used for digital photographs.
LCD	Liquid-Crystal Display -- the type of color display on the Thermal Imager.
LED	Light-Emitting Diode – used as light-up indicators
LED floodlight	A floodlight to illuminate the work area. It helps with the visual images, but does not change thermal images.
lens cap	A protective cover over the thermal imager lens.
level	The mid-way temperature point of the range in use. When you adjust the level, the width of the window from lowest to highest temperature stays the same and the whole window moves up or down in temperature.
Li-Ion	Lithium-Ion: the type of rechargeable battery used in the <i>MILWAUKEE</i> M12 series products.
load	The term for transferring images to a computer. You can load images directly from the SD card using the SD card reader USB adapter, or from the Thermal Imager with the SD card installed, using the USB cable.
M12	A family of <i>MILWAUKEE</i> 12V Li-Ion rechargeable battery powered tools, rechargeable batteries and accessories.
media door	The rubber cover over the SD card slot and Mini USB socket on the side of the Thermal Imager.

menu	On the Thermal Imager, a menu is a list of choices you can make for settings, such as time, date, color palette, span and emissivity.
microbolometer	The type of thermal infrared detector used in the Thermal Imager. It is an array of 160 by 120 thermal sensors that respond to infrared radiation (IR).
MILWAUKEE	Short for Milwaukee Electric Tool Corp., www.milwaukeetool.com . The mailing address for the company headquarters is 13135 W. Lisbon Rd., Brookfield, WI 53005, USA.
mini USB	The small USB data socket on the Thermal Imager and small USB plug on the USB interface cable. USB stands for Universal Serial Bus.
object temperature range	Same as temperature range: the lowest measurable temperature to the highest measurable temperature of a temperature measuring device such as the Thermal Imager.
operating temperature	The lowest ambient temperature to the highest ambient temperature in which you can operate the Thermal Imager.
palette	A thermal image color scheme. Generally, black is the coldest and white is the hottest, but you can choose the colors that represent the intermediate temperatures in the scale. Palette is one of the Setup menu choices in the Thermal Imager: IRON, RAINBOW and GRAY.
pixel	Picture element. One “dot” on the display or in a digital image. Many pixels are used to form an image.
precision	In a measurement device, precision is how close tightly grouped readings are. Accuracy combines precision and how close the reading is to a perfect measuring device or a calibration laboratory standard.
radiation, thermal	Infrared emission from a target area. Thermal radiation intensity drops off predictably with distance.
range	The lowest measureable temperature to the highest measureable temperature.

resolution	Same as “thermal sensitivity.” The number of meaningful digits in a temperature reading, for example, “10 °C, 10.1 °C, or 10.01 °C.” For the 10.01 °C reading, the resolution is “0.01 °C.”
saved image	An image written (recorded) onto the SD card installed in the Thermal Imager. Once saved, images stay intact on the SD memory card when you turn off the Thermal Imager power.
scale	The Thermal Imager uses your choice of two temperature scales: °C for Celsius or °F for Fahrenheit.
SD Card	Removable, reusable flash memory storage cards commonly used in digital cameras. The Thermal Imager accepts SD (up to 4 MB) and SDHC (for “High Capacity,” greater than 4 MB up to 32 MB) SD cards. It does not accept mini-SD or micro-SD cards.
sensor	Also called “detector,” or “thermal sensor,” the component that detects temperatures throughout the field of view. Model M12 160x120’s detector is a microbolometer. (See “microbolometer.”)
sleep mode	Automatic battery-conserving mode that begins after 5 minutes with no activity. The Thermal Imager remains ready to operate, so warm-up is not required when in sleep mode. This is not the same as auto power-off, which occurs after 20 minutes of no activity.
span	The width of the measurement window from the lowest measured temperature to the highest measured temperature. The “Level” setting moves this window up or down in temperature.
spectral range	The IR bandwidth, or longest to shortest infrared wavelengths that the Thermal Imager detects.
storage	Electronic memory (also called “Flash memory”) for saving the images and data created in the Thermal Imager during a work session. The Thermal Imager uses a standard SD (Secure Digital) removable, re-usable memory card as its sole storage system. Once images are loaded onto a computer, you can erase the SD card.

storage temperature	The lowest ambient temperature to the highest ambient temperature in which you can store the Thermal Imager while it is not being used.
target	The area in a thermal image in the center, defined by square corner markers on the display, whose temperature is displayed in 0.1 degree resolution at the top of the display. The temperature is the average of all the pixels contained within the brackets.
Thermal Imager	Shorthand name for the M12 160x120 Thermal Imager.
thermal imager lens	The main lens on the Thermal Imager that has the hinged lens cap. This lens focuses infrared radiation (IR) on the thermal sensor. There is another, smaller lens for taking visual digital images.
thermal mass	Objects with low thermal mass revert to ambient temperature more quickly than objects with low thermal mass. For example, a cast-iron engine block has higher thermal mass than an aluminum one. Thermal mass and mass are not the same thing.
thermal radiation	Infrared emission from a target area. Thermal radiation intensity infrared radiation drops off predictably with distance. This is why fixed-focus thermal imagers are less accurate than ones you focus. Focusing tells the Thermal Imager how far away the target is, so the imager can do the math to calculate the readings accordingly.
thermal sensitivity	The smallest increment of temperature measurement resolved by the digital reading. Equivalent to temperature resolution. (10 °C vs. 1 °C vs. 0.1 °C.)
thermal sensor	Also called “detector,” or “sensor,” the component that detects temperatures throughout the field of view. The Thermal Imager’s detector is an uncooled microbolometer.
thermographic study	Taking thermal images and interpreting them to check for problems, or to create a periodic record of temperatures for maintenance records.

toggle	Press the  button to switch between thermal visual image display and visual image display. the display This works in live mode as well as in image review mode.
trigger	The finger-lever at the top of the hand grip that you to take a thermal image. Pull it once to take the image and pull it again to save it to the SD card. (You have the choice after the first pull to save or choose CANCEL to discard the image.)
Type A USB	The larger, flat USB data socket on a computer and larger flat plug on the Thermal Imager's USB interface cable.
USB	Universal Serial Bus. The most common computer interface for connecting cameras, external disk drives and pocket-sized thumb drives.
visual image	A digital photograph that is saved with each thermal image, that provides visual context for what is in the thermal image.

USA - MILWAUKEE Service

MILWAUKEE prides itself in producing a premium quality product that is NOTHING BUT HEAVY DUTY®. Your satisfaction with our products is very important to us! If you encounter any problems with the operation of this tool, or you would like to locate the factory Service/Sales Support Branch or authorized service station nearest you, please call:

1-800-SAWDUST (1-800-729-3878)

Monday-Friday 7:00 AM – 6:30 PM Central

or visit the MILWAUKEE website at **www.milwaukeetool.com**

In addition, authorized distributors are ready to assist you with your tool and accessory needs. Check your local business-pages phone directory under "Tools-Electric" for the names and addresses of distributors nearest you, or see the "Where to Buy" section of www.milwaukeetool.com.

For Service Information, click on "Service Center Search" in the "Parts & Service" section of the *MILWAUKEE* website. For technical support or questions about service, repair or Warranty, contact *MILWAUKEE* Corporate After Sales Service Technical Support in any of these ways:

call: 1-800-SAWDUST(1-800-729-3878), FAX: 1-800-638-9582
or email: metproductsupport@milwaukeetool.com

Register your tool online at www.milwaukeetool.com and...

- receive important notifications regarding your purchase
- ensure that your tool is protected under the Warranty
- become a HEAVY DUTY club member

MEXICO - Soporte de Servicio MILWAUKEE

CENTRO DE ATENCIÓN A CLIENTES

Rafael Buelna No. 1, Col Tezozomoc, Delegación Azcapotzalco, México, D.F.
Telefono sin costo 01 800 832 1949, e-mail: servicio@ttigroupna.com

Adicionalmente, tenemos una red nacional de distribuidores autorizados listos para ayudarle con su herramienta y sus accesorios. Por favor, llame al 01 800 832 1949 para obtener los nombres y direcciones de los más cercanos a usted.

Canada - Service MILWAUKEE

MILWAUKEE prides itself in producing a premium quality product that is NOTHING BUT HEAVY DUTY®. Your satisfaction with our products is very important to us! If you encounter any problems with the operation of this tool, or you would like to locate the factory Service/Sales Support Branch or authorized service station nearest you, please call:

1-800-268-4015 Monday-Friday 7:00 AM – 6:30 PM Central

FAX: 1-866-285-9049, or visit the *MILWAUKEE* website at

www.milwaukeetool.com

In addition, authorized distributors are ready to assist you with your tool and accessory needs. Call the numbers above or see the "Where to Buy" section of www.milwaukeetool.com.

Milwaukee Electric Tool (Canada) Ltd.

140 Fernstaff Court, Unit 4
Vaughan, ON L4K 3L87

18129 111th Ave NW
Edmonton, AB T5S 2P2

MILWAUKEE est fier de proposer un produit de première qualité NOTHING BUT HEAVY DUTY®. Votre satisfaction est ce qui compte le plus! En cas de problèmes d'utilisation de l'outil ou pour localiser le centre de service/ventes ou le centre d'entretien le plus proche, appelez le : 1-800-268-4015 Lundi – Vendredi 7:00 – 4:30 Central.
FAX : 866-285-9049. Notre réseau national de distributeurs agréés se tient à votre disposition pour fournir l'aide technique, l'outillage et les accessoires nécessaires.

Composez le 1-800-268-4015 pour obtenir les noms et adresses des revendeurs les plus proches ou bien consultez le site web à l'adresse **www.milwaukeetool.com**

O consulte la sección <<Where to buy>> (Dónde comprar) de nuestro sitio web en:

www.ttigroupmexico.com

Registre su herramienta en línea, en www.ttigroupmexico.com y...

- reciba importantes avisos sobre su compra
- asegúrese de que su herramienta esté protegida por la garantía
- conviértase en integrante de Heavy Duty

MILWAUKEE ELECTRIC TOOL CORPORATION
13135 West Lisbon Road • Brookfield, Wisconsin, USA 53005